

NATIONAL INSTITUTE OF TECHNOLOGY

TIRUCHIRAPPALLI – 15

CENTRAL LIBRARY

Web : www.nitt.edu

Phone : 0431 - 2503761

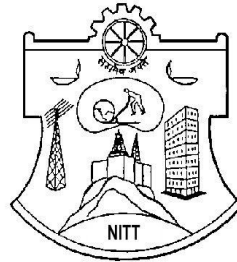

TENDER DOCUMENT

Tender Notification No.: F1/LIB/FURNITURE/PLAN FUND/2012-13

Dated: 20/01/2014

- Name of the component : **Furniture**
- Quantity required : **As per the Annexure**
- EMD Amount : **Rs. 50,000/-**
- Delivery : **4 – 6 weeks from the date of purchase order**
- Cost of the Tender Document : **Rs. 150/-**
- Last Date of submission of Tender : **28.02.2014 upto 3.00 PM**
- Address for submission of Tender : The Director,
National Institute of Technology,
Tiruchirappalli – 620015, Tamilnadu, India
Kind ATTN to: The Librarian, NIT, Trichy -15
- Date of opening of bid : **28.02.2014 at 3.30 PM**



NATIONAL INSTITUTE OF TECHNOLOGY
TIRUCHIRAPPALLI – 15

CENTRAL LIBRARY

Tender Notification No.: F1/LIB/FURNITURE/PLAN FUND/2012-13

Dated: 20/01/2014

NOTICE INVITING TENDER

The National Institute of Technology, Tiruchirappalli (NITT) is an autonomous body under MHRD, GOI, imparting Technical Education and engaged in Research Activities. It is proposed to procure the following component for the departmental academic/research activities.

Sealed Quotations under ***two cover system/Single bid*** are invited for the following component subject to the following terms and conditions, from the reputed manufacturers or their authorized dealers so as to reach this office on or before scheduled date and time. The technical cover will be opened on the same day in the presence of bidders or their authorized agents who may choose to be present.

Name of the component : Furniture
Quantity required : **As per the Annexure**
EMD Amount : **Rs. 50,000/-**
Delivery : **4 – 6 weeks from the date of purchase order**
Cost of the Tender Document : **Rs. 150/-**
Time for completion of supply after placing purchase order : **4 – 6 weeks from the date of purchase order**
Last Date of submission of Tender : **28.02.2014 upto 3.00 PM**

Tender to be submitted at the following address

The Director,
National Institute of Technology,
Tiruchirappalli – 620015, Tamilnadu, India
Kind ATTN to: The Librarian, NIT, Trichy -15

Place, Date and time of opening of bid :

Date: 28.02.2014

Time: 3.30 PM

Venue: Central Library

Note : The Institute shall not be responsible for any postal delay about non-receipt / non delivery of the bids or due to wrong addressee.

INSTRUCTIONS TO BIDDERS

BIDDER'S COPY

1. This document set contains the following:
 - a) Terms and conditions of the Tender
 - b) Details of the Firm offering this Quote
 - c) Technical Compliance Form
 - c) Quotation form (Price Bid)
 - d) Currency Form (quoted on behalf of the foreign suppliers)
 - d) NIT-T's check list copy
2. The bidder's copy is for your future records. Please fill in and return only NIT-T's copy.
3. The bidder should give details of their technical soundness and provide list of customers of previous supply of similar items to Universities, Institutes or Government Departments/Undertakings/public sectors with contact details. The details of the agency/profile should be furnished along with the copy of all related documents.
4. Read through the terms and conditions given and affix your signature and seal if you find them acceptable. Any deviations may be recorded. Read carefully list of specifications that we have enclosed.
5. Fill in the questionnaire regarding the Firm.
6. The downloaded documents '**Technical Compliance Form**' and '**Quotation Form (Price Bid)**' should be **TYPE WRITTEN USING CAPITAL LETTERS ONLY**. At the time of filling the "**Quotation Form (Price Bid)**" make sure that you have not missed anything. Specify the model number & specification for each item. The form should be filled item-wise. Do not leave blank fields. If you are not quoting for a specific item, you should specify "**NOT QUOTING**".
7. **Do not use** ambiguous terms like "**yes**", "**complied**" or "**available**". Specifically mention the matching specification of the product offered by you. Make sure that you have affixed your signature with date and seal on all the documents.
8. Please send the tenders in a sealed envelope super scribed as "**QUOTATIONS AGAINST TENDER NOTIFICATION NO: F1/LIB/FURNITURE/PLAN FUND/2012-13**" so as to reach "The Director, National Institute of Technology, Tiruchirappalli - 620 015, India" on or before **28/02/2014 at 3.00 PM along with a Softcopy of the Technical Compliance form and Quotation Forms in MS-Excel file format in a CD/DVD or USB drive.**
9. For any further clarifications, contact by E-Mail: thamarai@nitt.edu or by written request to "The Director, National Institute of Technology, Tiruchirappalli - 620 015, India"
10. Prebid conference will be held on 28/02/2014 at 3.30 PM

Last Date for receipt of tender at NIT-T : 28/02/2014 upto 3.00 PM
Opening Date for Tender : 28/02/2014 at 3.30 PM

CHECKLIST TO BE FILLED IN BY BIDDER

List of documents to be enclosed	Completed & Signed
1. Terms and Conditions form	YES / NO
2. Details of the Firm offering this Quote	YES / NO
3. NIT-T's Quotation form (Technical & Price Bid)	YES / NO
4. Currency Form(quoted on behalf of the foreign suppliers)	YES / NO
5. Other technical specifications & pamphlets	YES / NO

- Note:** 1. "Cover" should contain the following:
- a. Form of "**Acceptance of Terms and Conditions**".
 - b. Form of "**Firms details**"
 - c. Pamphlets, if any (in a separate sealed cover)
2. Quotation Form (Technical, Price Bid and Currency Form)

Please retain this page with you for your future reference.

Section 1. IN THE CASE OF TWO BID TENDERS

1.1 *Bids are to be submitted under two cover system.*

1.2 *Cover 1:*

Cover 1 should contain the following:

- a. *EMD - Earnest Money Deposit (EMD) is to be remitted by way of Demand Draft drawn on any Nationalized Bank in India by Demand Draft drawn on any scheduled bank in favour of “The Director, NIT, Trichy” payable at Trichy should be submitted. EMD shall bear no interest. Any bid not accompanying with EMD is liable to be treated as non-responsive and rejected.*
 - b. *Technical pamphlets*
 - c. *Detailed technical specification*
 - d. *The agency should furnish copy of license certificate for manufacture/supply of the item**
 - e. *The agency should furnish Income Tax PAN number & TIN number.**
 - f. *The agency should furnish the last three years balance sheet approved by the CA and the IT clearance certificate.**
 - g. *Warranty period offered for the tendered item to be specified. If the warranty period is not conforming with the schedule of requirements given in section 3 of the document, the bid is liable to be treated as non-responsive and rejected.*
 - h. *Duly filled up technical questionnaire, if any*
 - i. *Duly filled up deviation schedules to technical specification*
 - j. *Copy of supply orders completed during the last three years*
 - k. *If the prices are revealed in the cover 1, the offer will be summarily rejected*
- 1.3 *The cover 1 shall be super scribed as ‘Technical cover’ duly indicating the Tender reference No. and the due date of opening.*

** Appropriately pertaining to the country of origin.*

1.3 *Cover 2:*

Cover 2 should contain the following

Cover 2 shall contain Price only and shall be super scribed as ‘Price Cover’ duly indicating the Tender Reference No. and the due date of opening.

Each Cover shall be sent in a double sealed cover. The inner covers (Cover 1 and Cover 2) should be sealed individually with the Sellers’s distinctive seal and super scribed with the tender reference no. and due date of opening. Both the inner covers shall be placed in a common outer cover which shall also be sealed with seller’s distinctive seal and super scribed with the tender reference no. and due date of opening.

Mention “Kind Attention:The Librarian, NIT, Trichy -15, and submit at the address given in the Notice Inviting Tender.

Cover 1 will be opened on the scheduled date and time mentioned in the tender enquiry.

Cover 2 of the technically and commercially suitable offers alone will be opened on a date which will be intimated to the qualified bidders.

Section 2. “TERMS AND CONDITIONS FORM”

IMPORTANT: READ ALL THE FOLLOWING TERMS AND CONDITIONS AND SIGN THE ACCEPTANCE CLAUSE FOLLOWING IT

1. The offers should be addressed to “The Director, National Institute of Technology, Tiruchirappalli 620015, India” and should be sent in a sealed envelope super scribed “**QUOTATIONS AGAINST TENDER NOTIFICATION No.: F1/LIB/FURNITURE/PLAN FUND/2012-13**” so as to reach us **on or before 28/02/2014 at 3.00 PM**
2. Each offer should be sent in a sealed cover with the tender documents. Tenders received through email or FAX will not be considered. **Softcopy of the Technical Compliance form and Quotation Forms should be submitted along with the tender in MS-Excel file format in a CD/DVD or USB drive. However, if there is any dispute between Hard copy and Soft copy, Hard copy will be taken.**
3. The tenders will be opened on **28/02/2014 at 3.30 PM** in the presence of the vendors present with authorization letter from the respective companies / firms. Suppliers intending to attend the tender opening should intimate us in advance.
4. Full technical specifications and pamphlets should be sent along with the tenders. **Offers without proper technical specifications will be rejected.**
5. Samples should be supplied along with Technical Bid for Item Nos. (1 to 4) as in the annexure. **Bids without samples will be rejected.**
6. The rate quoted should be on unit basis excluding Taxes. Taxes and other charges should be quoted separately, considering exemptions if any.
7. All offers should indicate the taxes and duties applicable, if any. Additional charges for packing, forwarding, freight, insurance etc., if any, should be clearly mentioned. Clearance at Customs will be arranged by us.
8. NIT-T is paying concessional Customs & Excise duty under Government of India Notification No.51/96 for Central Customs and 10/97 for Central Excise Duty vide Certificate No.TU/V/RG-CDE(183)/2011 dt.10.10.11. Currently the purchaser is paying 5% Basic Customs Duty, 2% Educational Cess on Basic Customs Duty, 1% Higher Education Cess on Educational Cess, and 4% Import Additional Duty.
9. The Institute is not authorized to issue C and D forms of Sales tax certificate.
10. In case the offered items are to be imported, the rates should be quoted in foreign currency on C.I.F. Chennai Airport basis, and it should include the Freight up to Chennai airport and the insurance cover should be up to National Institute of Technology, Tiruchirappalli. NIT-T shall pay Customs duty if any.
11. If the price quoted is in foreign currency and if the order value is more than US\$10,000 then 100% payment will be made through **Letter of Credit (LC) at sight on acceptance**. If the order value is less than US\$10,000 , then 100% payment will be through a Telegraphic Transfer (TT). **The bank charges outside India should be borne by the Supplier / Beneficiary. Part shipment not allowed.** If the price quoted is in Indian Rupees, then 100% payment will be made only after installation and commissioning. **No advance payment will be made.**
12. No revision of the price bid will be allowed once the price bids are opened. In case of foreign currency, the agency should mention the % of currency fluctuations they can bear.
13. No increase in price will be allowed after our firm orders are placed.
14. **Payment of excise duty and sales tax / VAT (on ultimate products)** as applicable on the closing date of tender will be to the supplier’s / contractor’s account. Any statutory variation (both plus and minus) in the rate of excise duty/sales tax/VAT after closing date of tender/revised price bid but before the expiry of the contractual delivery / completion period will be to the account of the office.
The bidder(s) will indicate, in their bid, the amount with exact rate of the Excise and Sales tax/VAT on ultimate finished product, as applicable at tendering stage, separately in the bid. In case the above information subsequently proves wrong, incorrect or misleading (a) this Institute will have no liability to reimburse the excess in the difference in rates of the item under which the duty/tax assessed finally (b) this Institute will have the right to recover the difference in case the rate of duty / tax finally assessed is on the lower side.

Any increase in excise duty, sales tax / VAT during extended period of the contract / supply order will be to supplier's / contractor's account where such extension in delivery of the materials/completion of the project was on the request of supplier / contractor. However, any decrease in excise duty/sales tax/ VAT during extended period of the contract / supply order, will be to the account of this Institute.

15. The warranty period should be clearly mentioned. The maintenance charges (AMC) under different schemes after the expiry of the warranty should also be mentioned.
16. Quote should come from authorized dealer or distributor or reseller for each of the product quoted. An authorization letter should accompany your quote for each product quoted; otherwise it may lead to rejection.
17. The delivery period and other terms should be clearly mentioned.
18. Eligibility: Quotation from registered firms/company's / manufacturer under TNGST/CST / other statutory bodies alone be considered. Any Manufacturer / Supplier / Dealer who has been declared ineligible by World Bank/government of India shall not be eligible to participate in this bid. Any fraudulent practices including concealing of facts at the time of submission of bid and there after shall lead to disqualification. List of beneficiaries especially from Educational Institutions / R & D Institutions should also be enclosed with the quotations.
19. For those instruments Cost exceeding 5,00,000/- the company should have (i) Three similar works, each of value not less than 40% of the estimated cost put to tender, or (ii) Two similar works, each of value not less than 50% of the estimated cost, or (iii) One similar work of value not less than 80% of the estimated cost, all amounts rounded off to a convenient full figure, in the last 7 years ending on the last day of the month previous to the one in which the tenders are invited.
20. Complete user, technical and service documentation, and spare parts catalogue are to be provided along with the supply of the item.
21. The vendors are informed that they should not call us over phone or contact us in person. All clarifications can be obtained through E-Mail/FAX/Post. Vendors shall not make attempts to establish unsolicited and un-authorized contact with us after the opening of the offers and prior to the notification of the award. Any attempt by any vendor to bring to bear extraneous pressures on us shall be sufficient reason to disqualify the vendor.
22. Delay / loss in postal transit or due to other reasons will not be NIT-T's responsibility.
23. We are not responsible for accidental opening of the covers that are not properly super scribed and sealed before the time scheduled for opening.
24. The tender should be made only on the "Technical compliance form" & "Quotation form" which is available in our website, otherwise it shall lead to rejection. The technical compliance form & PRICE BID FORM should be duly filled up (preferably **TYPE WRITTEN IN CAPITAL LETTERS**) and should clearly mention the features offered by the bidder against each specification.
25. Authorized signatory should sign on all the pages. Bids without authorized signatures will be rejected.
26. The manufacturers of the quoted make of the product must be of national / international repute and having ISO /BIS certificate.
27. **Liquidated damages:** If the bidder/supplier, after accepting the Purchase Order, fails to deliver any or all of the Goods within the period specified in the Order, NIT-T shall, without prejudice to its other remedies under the Rules of Purchase, proceed to cancel the order or agree to accept a delayed delivery on the condition of payment of liquidated damages by the bidder / supplier a sum equivalent to 0.50% of the total cost as indicated in the Purchase Order (which will be deemed as agreed price) for each week or part thereof of delay until actual delivery or performance is completed and such penal charges shall be limited to a maximum of 5% of the total cost. Once the maximum is reached NIT-T may proceed on its own to consider the termination / cancellation of the order.
28. **The vendors are informed that they should sign a stamp paper agreement with us, for Warranty, AMC, etc. before placing the final purchase order as per our terms & conditions and 5% -10% of purchase order value in the form of bank guarantee towards performance security. The bank guarantee will be returned to the supplier after the successful completion of supply, installation, and the warranty period.**
29. Failure to comply with all the terms and conditions mentioned herein would result in the tender being summarily rejected.

30. Vendors are informed that once the companies are shortlisted based on the technical specification, only then the price bids of the firms that meet NIT-T's Technical specification / requirements would be compared.
31. The order will be based on the actual requirement at the time of ordering, optional items may also be ordered based on the actual requirements at the time of ordering. Not quoting for this may result in disqualification.
32. NIT-T reserves the right to modify or alter the specifications after short listing of tenderers.
33. NIT-T reserves the right to change the order quantity or split the orders among multiple vendors without assigning any reason(s) whatsoever.
34. NIT-T reserves the right to reject any or all the tenders without assigning any reasons whatsoever.
35. NIT-T reserves the right to purchase decreased number of quantity of the item to be purchased
36. The agencies should submit their rate as per the format given in Section 4 of the Notice Inviting Tender in this cover. All the pages of the bid should be signed affixing the seal. All corrections and overwriting should be initialed.
37. The tender will be acceptable only from the manufacturers or its authorized supplier.
38. The bid shall be in the format of price schedule given in Section 4. The contract form as per format given in section 5 shall be submitted. Incomplete or conditional tender will be rejected.
39. Details of quantity and the specifications are mentioned in Section 3 appended to this Notice Inviting Tender
40. The item to be used is strictly according to the specification and subject to test by the Institute/concerned authorities. It must be delivered and installed in good working condition.
41. The Contractor/Supplier shall have no claim to any payment of compensation or otherwise whatsoever, on account of any profit or advantage which he might have derived from the execution of the work/supply in full but he did not derive in consequence of the foreclosure of the whole or part of the works.
42. In case of dispute, the matter will be subject to Tiruchirappalli, Tamil Nadu Jurisdiction only.

Release of EMD: The EMD shall be released after receipt of performance security from successful bidder.

Validity of bids: The rate quote should be valid for a minimum of 120 days. No claim for escalation of rate will be considered after opening the Tender.

Imports: In case, goods are to be imported, the Indian agent should furnish authorization certificate by the principles abroad for submission of the bid in response to this Notice Inviting Tender.

Clarification of Tender Document: A prospective bidder requiring any clarification of the Tender document may communicate to the contact person given in this notice inviting tender.

Amendment of tender document: At any time prior to the last date of receipt of bids, Institute may for any reason, whether at its own initiative or in response to a clarification requested by prospective bidder, modify the Tender document by an amendment.

The Institute may at its own discretion extend the last date for the receipt of bids.

The bids shall be written in English language and any information printed in other language shall be accompanied by an English translation, in which case for the purpose of interpretation of the bid, the English translation shall govern.

The Institute reserves the right of accepting any bid other than the lowest or even rejecting all the bids without assigning any reasons therefore. The decision of the Institute Purchase Committee is final in all matters of tender and purchase.

The bidder should give the following declaration while submitting the Tender.

ACCEPTANCE

We accept the above terms and conditions and shall comply with them strictly.

NAME OF THE VENDOR:

ADDRESS :

“DETAILS OF THE FIRM OFFERING THIS QUOTE”

(Write or print or type in block letters and please answer all the questions)

1. Name of the firm? 2. Date of incorporation?
3. Nature of the company - Government / Public / Private Company / Partnership / Proprietorship:
4. Specify the number of years in this line of activity by the Company ::

5. Quantity of sales in the last three years for the “.....” (same model that you have quoted)?

2009-2010	2010-2011	2011-2012
<input type="text"/>	<input type="text"/>	<input type="text"/>

6. Turn over in the last three years (Figures should be in Indian Rupees in Lakhs):

2009-2010	2010-2011	2011-2012
<input type="text"/>	<input type="text"/>	<input type="text"/>

7. Provide the postal address, telephone & fax numbers, and email address of the nearest service center.

8. A) Number of service engineers in the above location trained on the product quoted along with their educational qualification, certification and designation (applicable only for instruments) and B) Assured response time for service calls in hours:

A)

B)

9. What would be the delivery period in days from the date we place an official purchase order.

2. Enclose the list of customers to whom you have supplied “.....” during the last 3 years ending 31/03/2012 with full postal address and name of the contact person with phone, FAX numbers, and E-Mail id. Certificate regarding satisfactory performance of the “.....” from the minimum three end users should be furnished.

3. Are you the authorized dealer or distributor or reseller for the products quoted:

4. Have you supplied “.....” to National Institute of Technology, Tiruchirappalli in the last 3 years? If yes, specify the quantity supplied in the last 3 years and last PO reference

5. Was there any elapse or delay in supplying the goods ordered or any service related issue during the warranty period for the products ordered by NIT-T with your firm? If yes, provide details.

--

6. On Manufacturer's Side to whom NITT have to contact in case of delayed supply and other issues committed by the authorized dealer / distributor / reseller :

Contact Person Name :	
Address :	
E-mail ID :	Telephone / Cell Phone :

DECLARATION

I/we have not tampered/modified the tender forms in any manner. In case, if the same is found to be tampered/modified, I/we understand that my/our tender will be summarily rejected and full Earnest Money Deposit (EMD) will be forfeited and I/we am/are liable to be banned from doing business with NIT, Trichy and /or prosecuted.

Signature of the Bidder :

Name and Designation :

Business Address :
.....
.....

Place :

Date :

Seal of the Bidder's Firm

SECTION : 3 SCHEDULE OF REQUIREMENTS, SPECIFICATIONS AND ALLIED DETAILS

Name of the Component to be procured : Furniture

Specification for Furniture

Name of the Component to be procured : **Furniture**

Specifications : List attached (As per the Annexure)

Quantity : As per the Annexure

Any other details/requirement : List attached (As per the Annexure)

Warranty period required : One year or more

Delivery schedule expected after release of purchase order (in weeks) : 4 – 6 weeks from the date of purchase order

EMD (in Rupees) : Rs. 50,000/-

Performance Security to be given by Successful bidder after release of purchase order (in Rupees) : 5% of the equipment cost

SECTION : 4 PRICE SCHEDULE

[To be used by the bidder for submission of the bid]

1. Component Name :

2. Specifications (confirming to Section 3 of Tender document-enclose additional sheets if necessary) :
3. Currency and Unit Price(excluding Taxes) :
4. Quantity :

5. Item cost (Sl.No.3 & Sl.No.4) (in Indian Rupee) :

6. Taxes and other charges :
 - (i) Specify the type of taxes and duties in percentages and also in figures
 - (ii) Specify other charges in figures :

7. Warranty period (confirming to the Section 3 of Tender document. This should be mentioned in Technical bid also in order to get qualified for Financial bid) :
8. Delivery Schedule (confirming to the Section 3 of Tender document) :
9. Name and address of the firm for placing purchase order :

10. Name and address of Indian authorized agent (in case of imports only) :

Signature of the Bidder :

Name and Designation :

Business Address :
.....
.....

Place :

Date :

Seal of the Bidder's Firm

SECTION : 5 CONTRACT FORM

[To be provided by the bidder in the business letter head]

1. (Name of the Supplier's Firm) hereby abide to deliver theby the delivery schedule mentioned in the Section 3 tender document for supply of the items if the purchase order is awarded.
2. The item will be supplied conforming to the specifications stated in the tender document without any defect and deviations.
3. Warranty will be given for the period mentioned in the tender document and service will be rendered to the satisfaction of NIT, Trichy during this period.

Signature of the Bidder :

Name and Designation :

Business Address :
.....
.....

Place :

Date :

Seal of the Bidder's Firm

ANNEXURE

NITT SPECIFICATION FOR FURNITURE

Item No. 1. VISITOR CUSHION CHAIRS (Qty – 125)

- **Seat / Back assembly:** Should be made of 10 mm thick hot pressed plywood with suitable injection moulded polymer which is upholstered with fabric and moulded polyurethane foam. A contoured lumber support should be provided with back foam for extra comfort.
- **Seat / Back covers :** suitable injection moulded polymer
- **Foam :** Polypropylene with density not less than 40 kg/m³
- **Frame :** Black powder coated mild steel tube of diameter not less than 25 mm and 14BG thickness
- **Type :** Non-revolving
- **Cushion Colour:** Blue
- **Variations within ± 10 mm for W, D, H & SH**

**ISO, BSOHSAS, BIFMA, Green Guard Certification etc. are essential requirements for the Bidder.
Full technical specification pamphlets are to be submitted.**

Item No. 2. CUSHION CHAIRS WITH DESKLET/WRITING PADS & ARMRESTS (Qty – 175)

- **Seat / Back assembly:** Should be made 10-12 mm thick and seasoned wood and plywood. Upholstered with Black Synthetic leather and polyurethane foam. A contoured lumber support should be provided with back foam for extra comfort. The back flexing features should be allowed the back to tilt by 9°±2° to aid the user in adopting a comfortable reclining posture.
- **Seat / Back covers :** suitable injection moulded polymer
- **Foam :** Polyurethane with density not less than 70 kg/m³ and hardness not less than 20 kg/m³ for seat and not less than 16 kg for back at 25% compression.
- **Armrests:** The armrest structure should be made up of not less than 23mm dia and not less than 2.7mm thick M.S.E.R.W. The Tube should be welded to the Tubular Frame structure and should have a scratch-resistant ABS Arm top.
- **Full Desklet:** The Full Desklet assembly should be Flip-up type and made up of extension tube of not less than 20mm dia x not less than 2.16mm thick M.S.E.R.W. Tube on which a scratch resistant ABS desklet top to be fixed and covered on bottom side with a bottom cover.
- **Frame :** Black powder coated mild steel tube of diameter not less than 25 mm and 14BG thickness
- **Colour:** Black
- **Variations within ± 10 mm for W, D, H & SH**

**ISO, BSOHSAS, BIFMA, Green Guard Certification etc. are essential requirements for the Bidder.
Full technical specification pamphlets are to be submitted.**

Item No. 3: BOOK SUPPORTS / BOOK ENDS (Qty – 1000)

- **Width (W): 190 mm**
- **Height (H): 200 mm**
- **Thickness of plate = 2mm**

Item No. 4: LIBRARY BOOK TROLLEYS (Qty – 8)

- **Frame:** should be made of Steel frame not less than 25 mm Outside Diameter (O.D.).
- **Wheels:** The Brake-Loaded Castors should be assembled to the trolley's wheels/legs to give a free movement for manoeuvring the trolley when not in use and it should break the movement when load is applied (while in use) to give a stable feel.
- **Rows:** Three row. Each rows should carry and support not less than 50 kg
- **Handles:** Steel Handles not less than 45 mm Breadth and not less than 25 mm Outside Diameter (O.D.)
- **Variations within ± 10 mm for W, D & H**

Item No. 5: STEEL TABLES WITH DRAWERS (Qty – 5)

- **Top Lipping:** Teak or Rosewood / 18 mm thk.
- **Wooden workspace** top made from 25mm PLB top sealed four side with 2mm thick PVC leaping and post forming edges, making them highly resistant from heat and moisture
- **Metal under-structure:** C-Frame CRCA MS sheet of 0.9mm thick with powder coating, Tubular frame MS ERW powder coated square tubular frame, Modesty panel 1.0mm thick CRCA sheet
- **Drawer Units:** One set of storage unit. 3 drawer unit.
- **Lock: 6 lever brass lock**
- **Handles** built in metal with assembling, installation etc
- **Colour: Ivory**
- **Variations within ± 10 mm for W, D, H & SH**

ISO, BSOHSAS, BIFMA, Green Guard Certification etc. are essential requirements for the Bidder. Full technical specification pamphlets are to be submitted.

Item No. 6: DISPLAY STEEL CUP-BOARDS WITH GLASS DOORS

- High yield strength CRCA
- Each door with Lock and common key and handles.
- Storage shelf with loading capacity of 80 kg max.
- Finish: Epoxy Polyester Powder coated to the thickness of 50 microns (± 10).
- **Variations within ± 10 mm for W, D & H**

ISO, BSOHSAS, BIFMA, Green Guard Certification etc. are essential requirements for the Bidder. Full technical specification pamphlets are to be submitted.

Item No. 7: NEWS PAPERS DISPLAY STAND (Qty – 2)

- **Color:** Brown
- **Packaging:** 4pcs/box
- **Variations within ± 10 mm for W, D & H**

ISO, BSOHSAS, BIFMA, Green Guard Certification etc. are essential requirements for the Bidder. Full technical specification pamphlets are to be submitted.

Item No. 8: COMPUTER TABLES (Qty – 5)

- **Wooden workspace** top made from 25mm PLB top sealed four side with 2mm thick PVC leaping and post forming edges, making them highly resistant from heat and moisture
- **Drawer Units:** One set of storage unit. 1 drawer unit with an open shelf.
- **Lock: 6 lever brass lock**
- **Handles** built in metal with assembling, installation etc
- **Color: Bavarian Beech**
- **Variations within ± 10 mm for W, D & H**

ISO, BSOHSAS, BIFMA, Green Guard Certification etc. are essential requirements for the Bidder. Full technical specification pamphlets are to be submitted.

Item No. 09: MODERN CORNER SOFAS (Qty – 2 Sets)

- **Cover Fabric:** Cotton and Linen Mixed
- **Color:** Coffee Brown Fabric
- **Variations within ± 10 mm for W, D, H & SH**

ISO, BSOHSAS, BIFMA, Green Guard Certification etc. are essential requirements for the Bidder. Full technical specification pamphlets are to be submitted.

Item No. 10: TEAPOY WOODEN TABLE (Qty – 2)

- **Color:** Coffee Brown
- **Variations within ± 10 mm for W, D & H**

ISO, BSOHSAS, BIFMA, Green Guard Certification etc. are essential requirements for the Bidder. Full technical specification pamphlets are to be submitted.

Item No. 11: VERTICAL FILING CABINET (4 TRAYS) - (Qty – 1)

- **Material :** Steel sheet of cold rolled and annealed with suitable thickness for rigidity
- **Handle :** Integrated full length handle
- **Locking arrangement :** Centralized locking with 10 lever cam lock
- **Slide:** Precision ball slide.
- **Drawer load not less than 40 kg**
- Epoxy polyester powder coating with thickness not less than 50 microns
- Suitable arrangements to be provided for hanging files in each drawer
- **Colour:** White
- **Variations within ± 10 mm for W, D & H**

ISO, BSOHSAS, BIFMA, Green Guard Certification etc. are essential requirements for the Bidder. Full technical specification pamphlets are to be submitted.

Item No. 1. VISITOR CUSHION CHAIRS (Qty – 125)

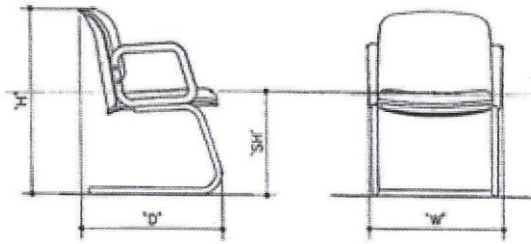

Width (W) = 550 mm
Depth (D) = 610 mm
Height (H) = 805 mm
Seat Height (SH) = 440 mm

Item No. 2. CUSHION CHAIRS WITH DESKLET/WRITING PADS & ARMRESTS (Qty – 175)

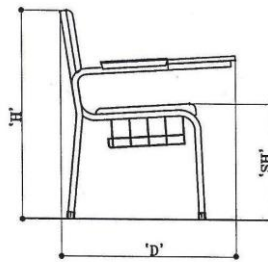

Width (W) = 540 mm
Depth (D) = 675 mm
Height (H) = 855 mm
Seat Height (SH) = 480 mm

Item No. 3: BOOK SUPPORTS / BOOK ENDS (Qty – 1000)

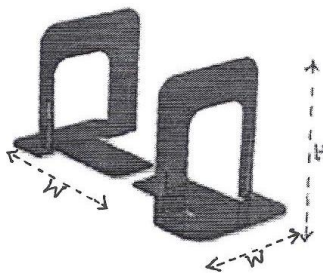

Width (W) = 190 mm
Height (H) = 200 mm
Thickness of Plate = 2 mm

Item No. 4: LIBRARY BOOK TROLLEYS (Qty – 8)

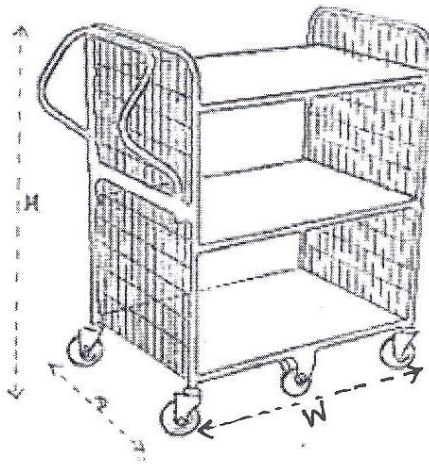

Width (w) = 1200mm
Depth (D) = 450mm
Height (H) = 900mm

Item No. 5: STEEL TABLES WITH DRAWERS (Qty – 5)

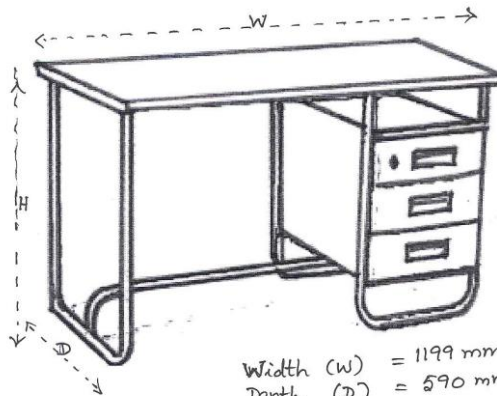

Width (w) = 1199 mm
Depth (D) = 590 mm
Height (H) = 750 mm

Item No. 6: DISPLAY STEEL CUP-BOARDS WITH GLASS DOORS

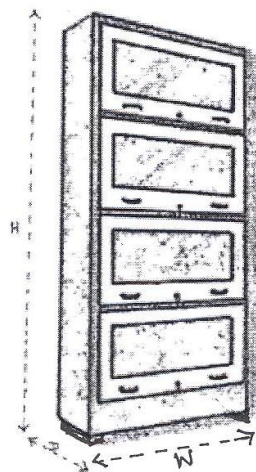

Width (W) = 914 mm
Depth (D) = 320 mm
Height (H) = 1742 mm

Item No. 7: NEWS PAPERS DISPLAY STAND (Qty – 2)

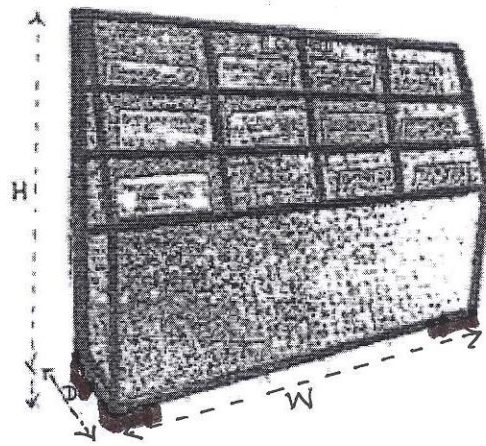

Width (W) = 1225 mm
Depth (D) = 600 mm
Height (H) = 1350 mm

Item No. 8: COMPUTER TABLES (Qty – 5)

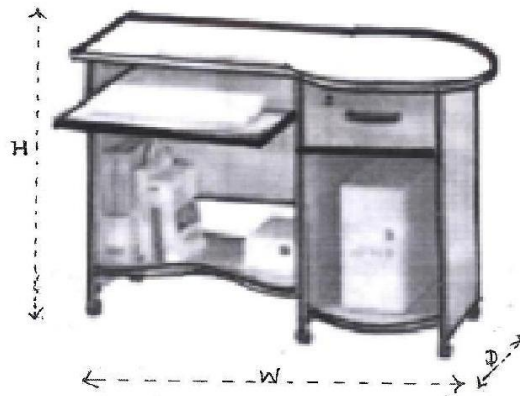

Width (W) = 1230 mm
Depth (D) = 610 mm
Height (H) = 770 mm

Item No. 9: MODERN CORNER SOFAS (Qty – 2 Sets)

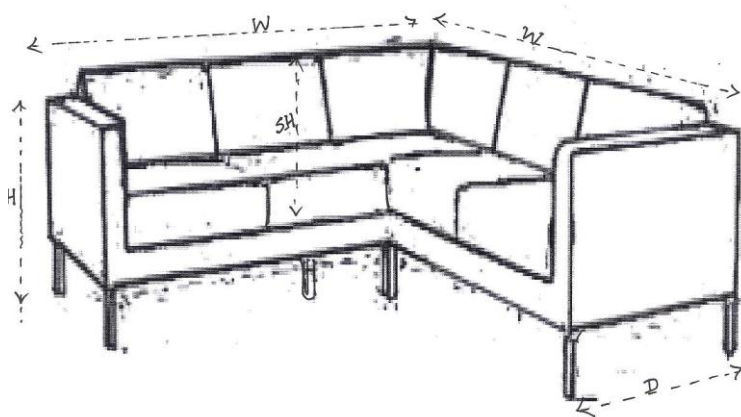

Width (W) = 2650 x 2650 mm
Depth (D) = 1010 mm
Height (H) = 900 mm
Seat Height (SH) = 450 mm

Item No. 10: TEAPOY WOODEN TABLE (Qty – 2)

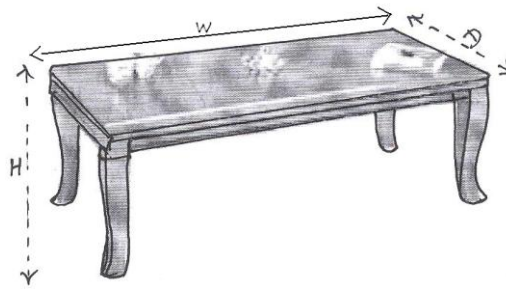

Width (W) = 1200 mm
Depth (D) = 600 mm
Height (H) = 450 mm

Item No. 11: VERTICAL FILING CABINET (4 TRAYS) - (Qty – 1)

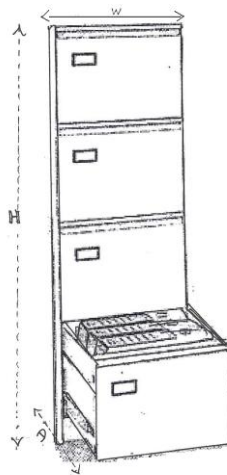

Width (W) = 470 mm
Depth (D) = 620 mm
Height (H) = 1320 mm